

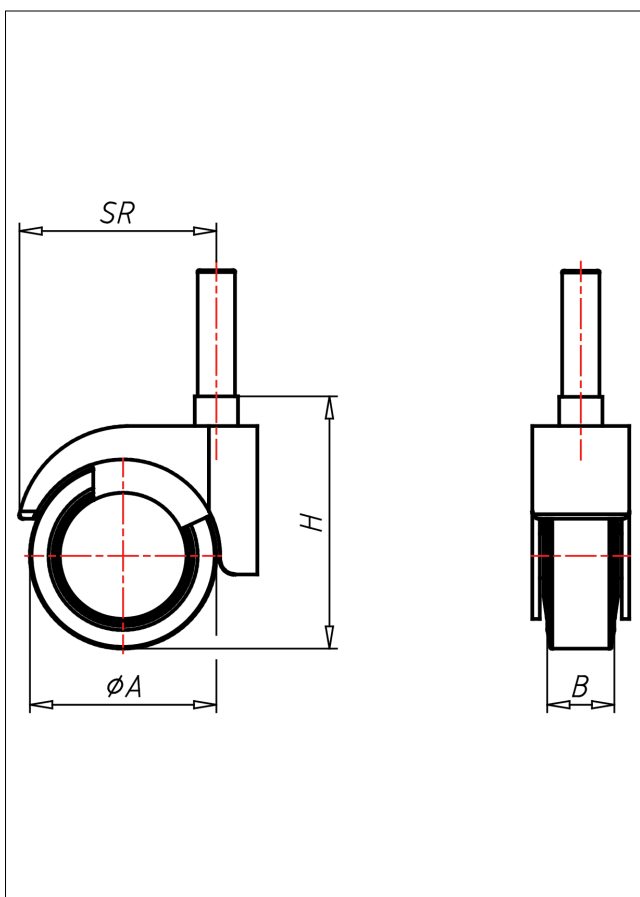

475 DE

Lenkrolle

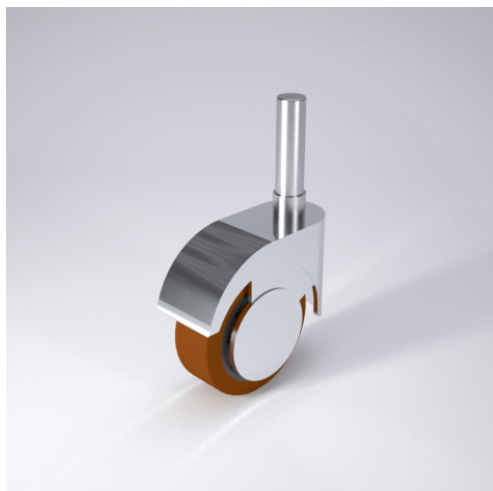

475-DE



+60 °C
-20 °C

max.
40 kg



Gehäuse: Zinkdruckguss - verchromt
Schwenklager mit kombiniertem
Gleit-Kugellager
Felge Polyamid 6
elastischer PUR-Reifen - spurfrei
Radfeststeller glasfaserverstärkt
Radachse verschraubt

Technische Details

ORDERNO (Artikel-nummer)	475 11x22 50 DE
WDAB (Rad-Ø A x Breite B / mm)	50x18
LC (Tragkraft / kg)	40
H (Bauhöhe H / mm)	68
BOLT (Stift / mm)	11x22
SR (Schwenkradius / mm)	51
WB (Radlager)	Polyamid-Gleitlager